

FICHA DE EXPERTOSAURIO

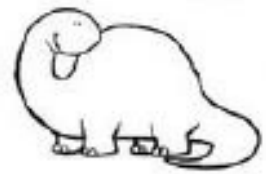

Expertosaurio/a del día: _____

Hemos aprendido sobre el _____
que significa: _____

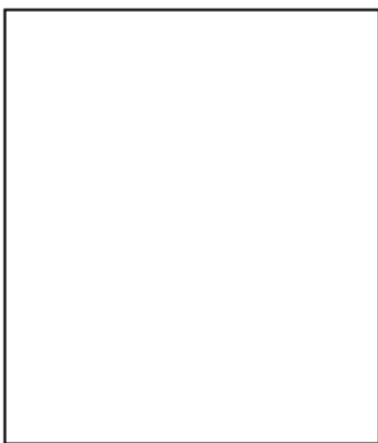

Más datos...



_____ metros



_____ kilogramos

Comía _____



Se desplazaba por _____



Dientes en forma de _____

Se defendía por medio de _____

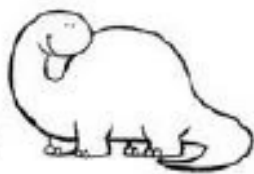



DIBUJO IDEAS PREVIAS

¿QUÉ SABEMOS DE LOS DINOSAURIOS?



EL NACIMIENTO DE LOS DINOSAURIOS

1

2

3

PEGA LA SECUENCIA DE NACIMIENTO DEL DINOSAURIO.

EL NACIMIENTO DE LOS DINOSAURIOS

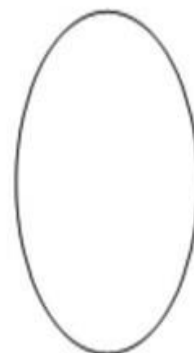

PARTES DEL CUERPO





PARTES DEL CUERPO

DIENTES

CUELLO

GARRAS

COLA

GARRAS

PATAS

SU ESQUELETO

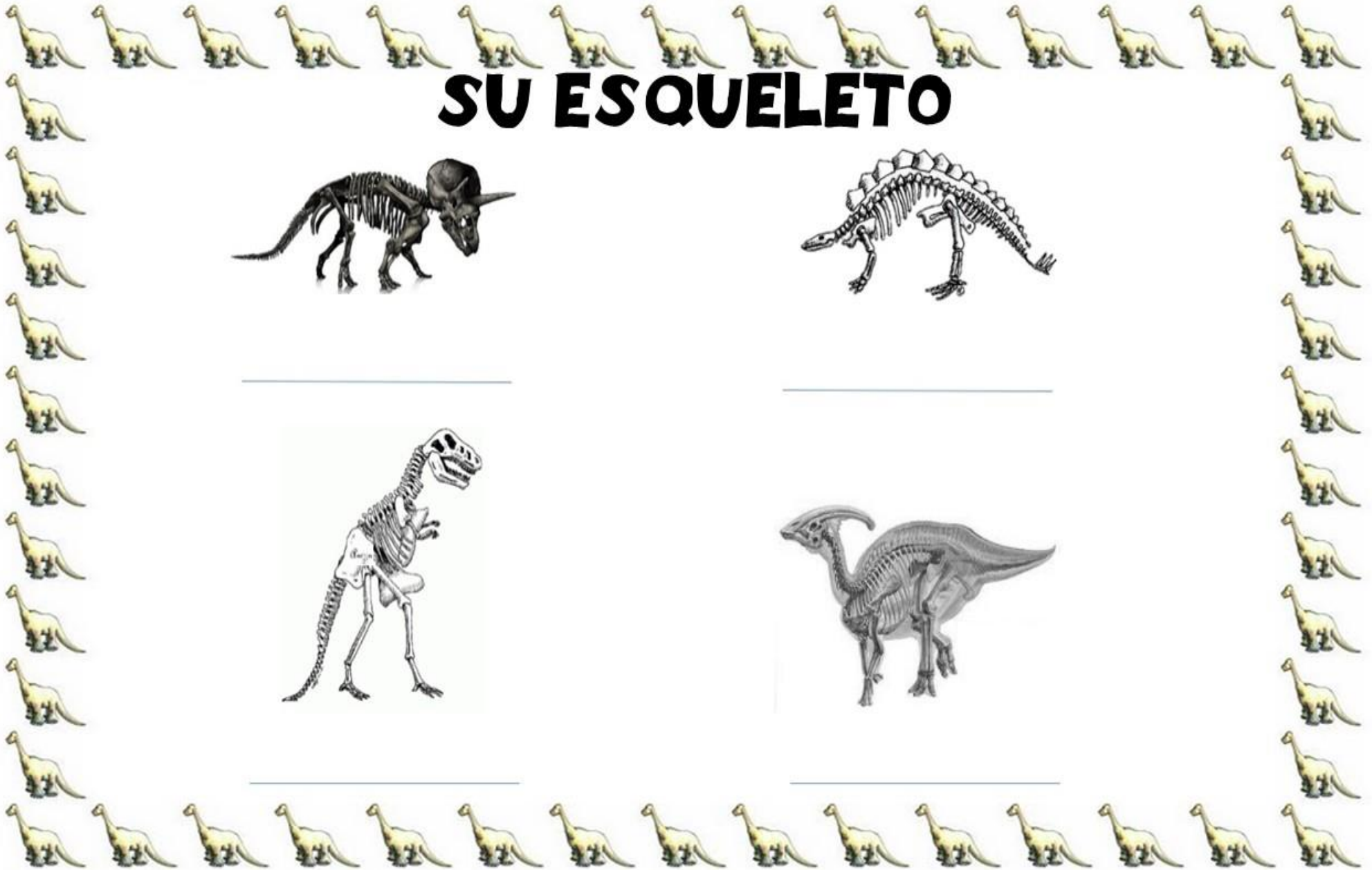
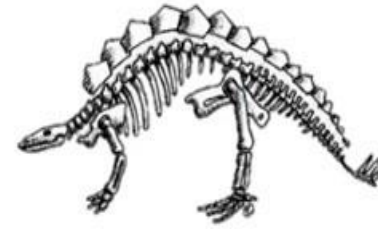

NUESTRAS HUELLAS

LA HUELLA DE...



LA HUELLA DE...



SU HÁBITAT

TIERRA



MAR



AIRE



SU HÁBITAT



¿QUÉ COMEN?

CARNIVOROS

HERBIVOROS

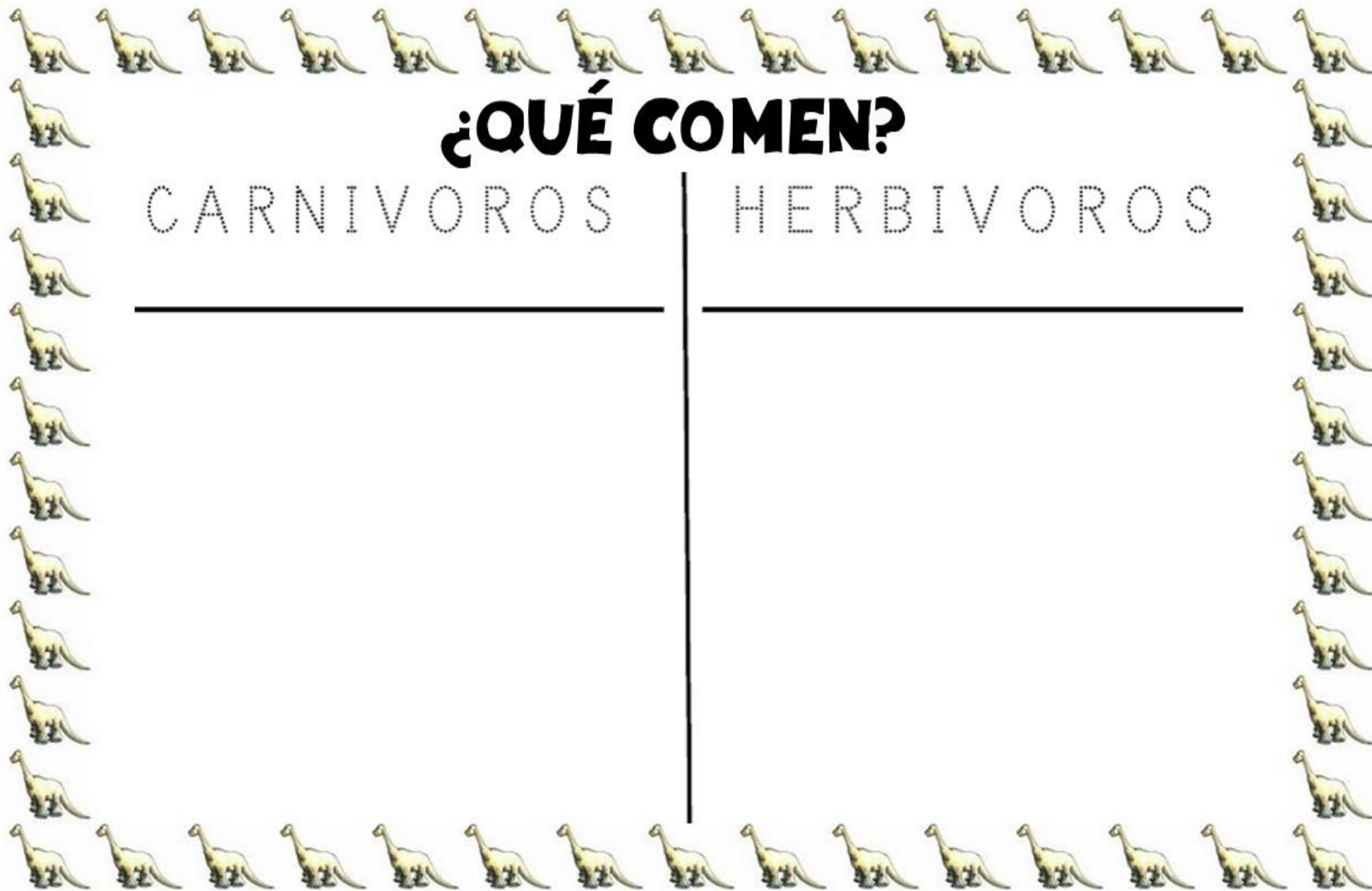

¿QUÉ SIGNIFICA MI NOMBRE?

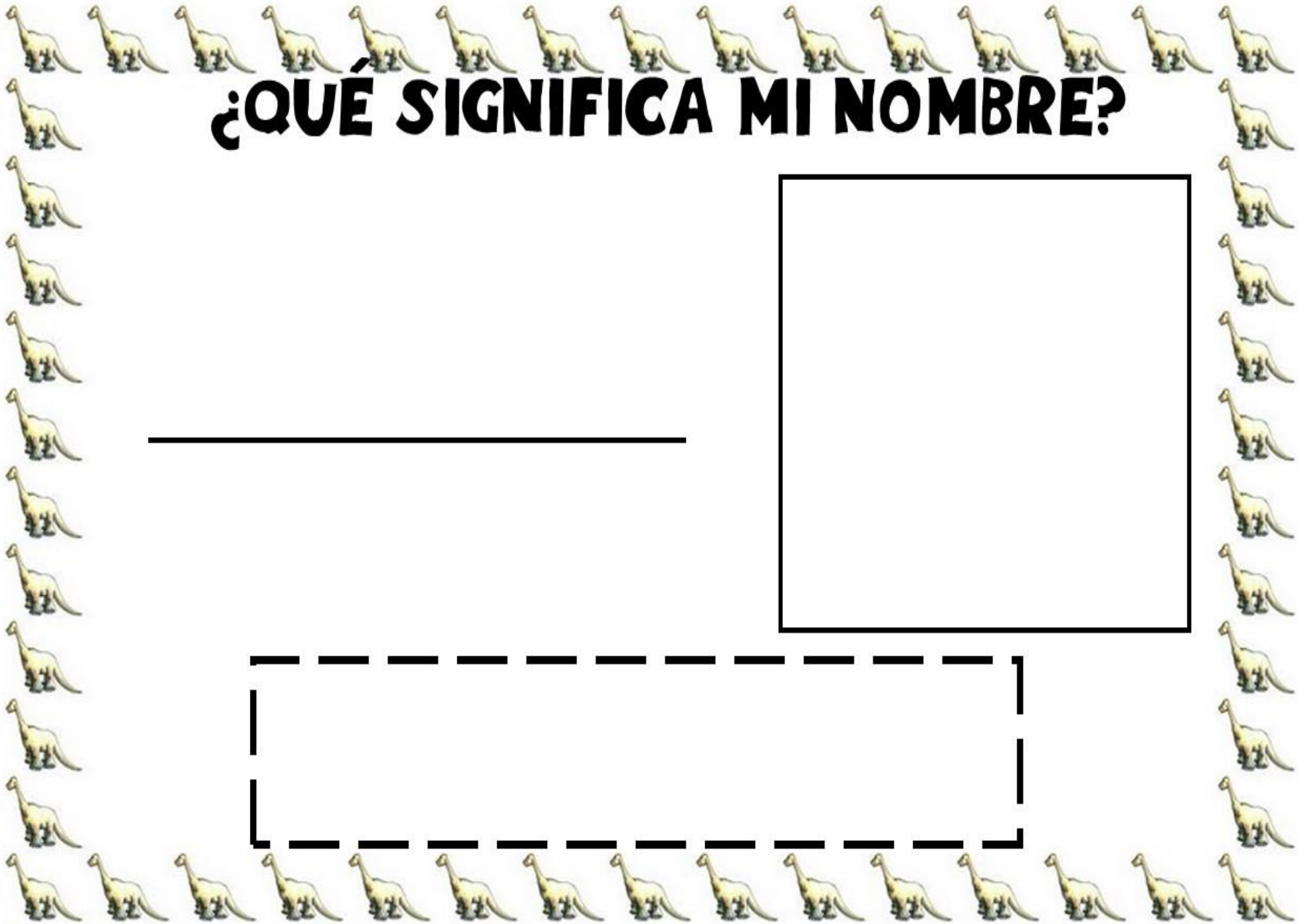
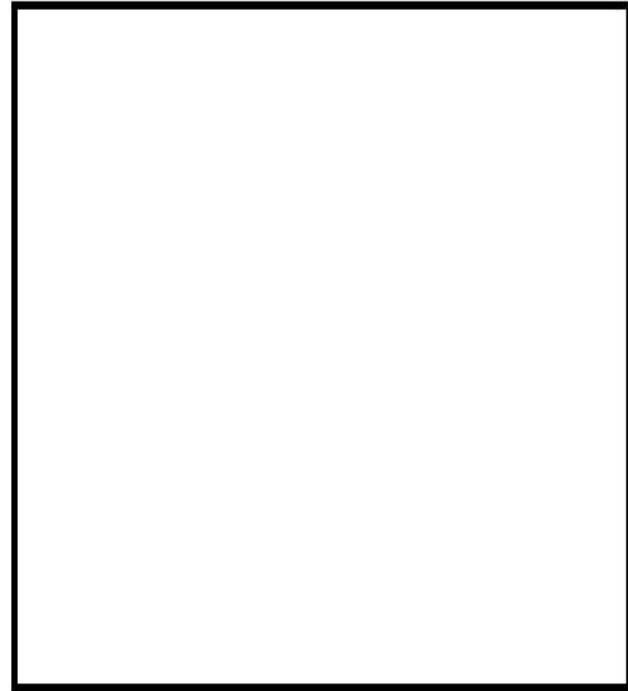

PALEONTOLOGÍA

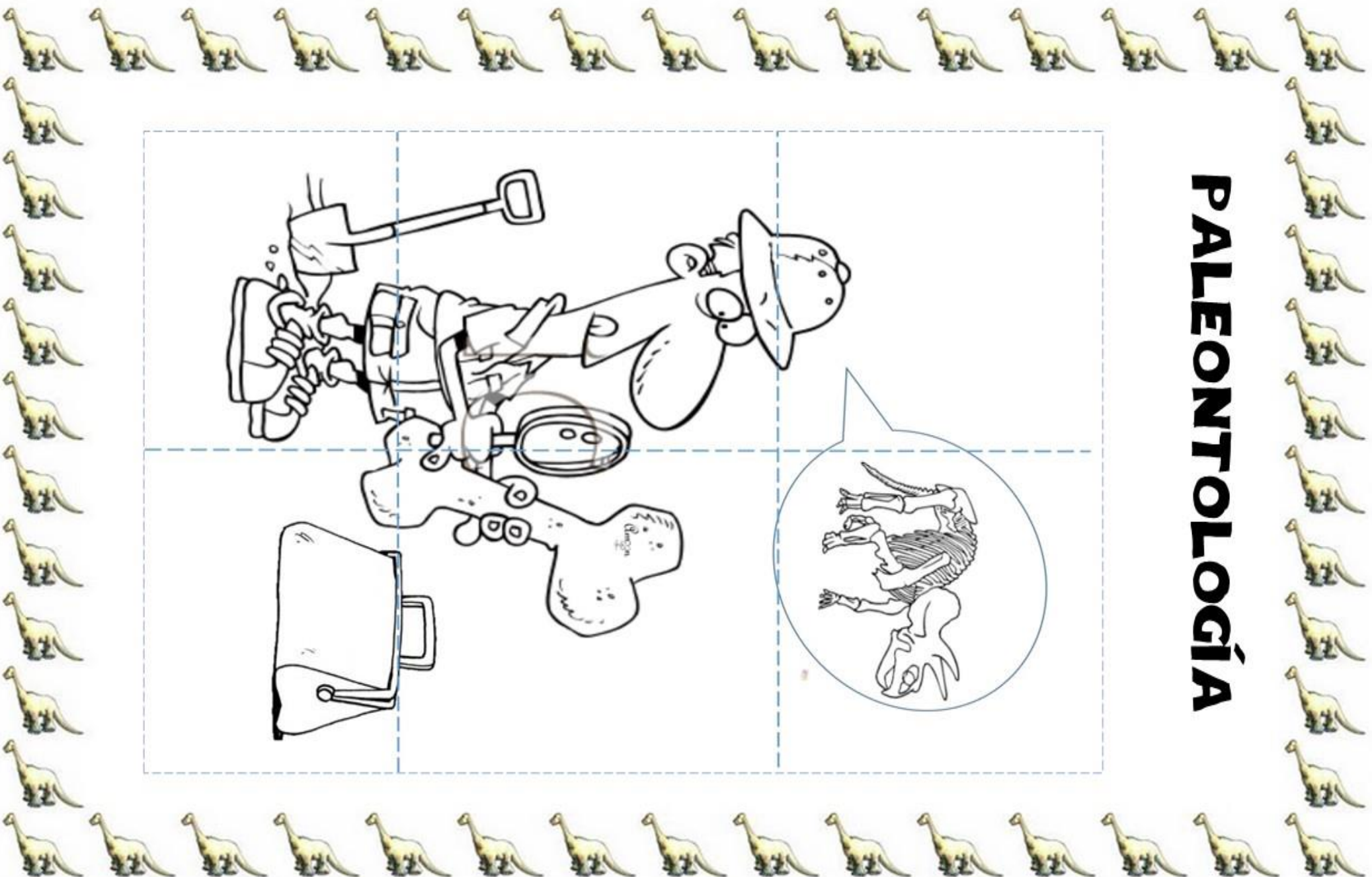
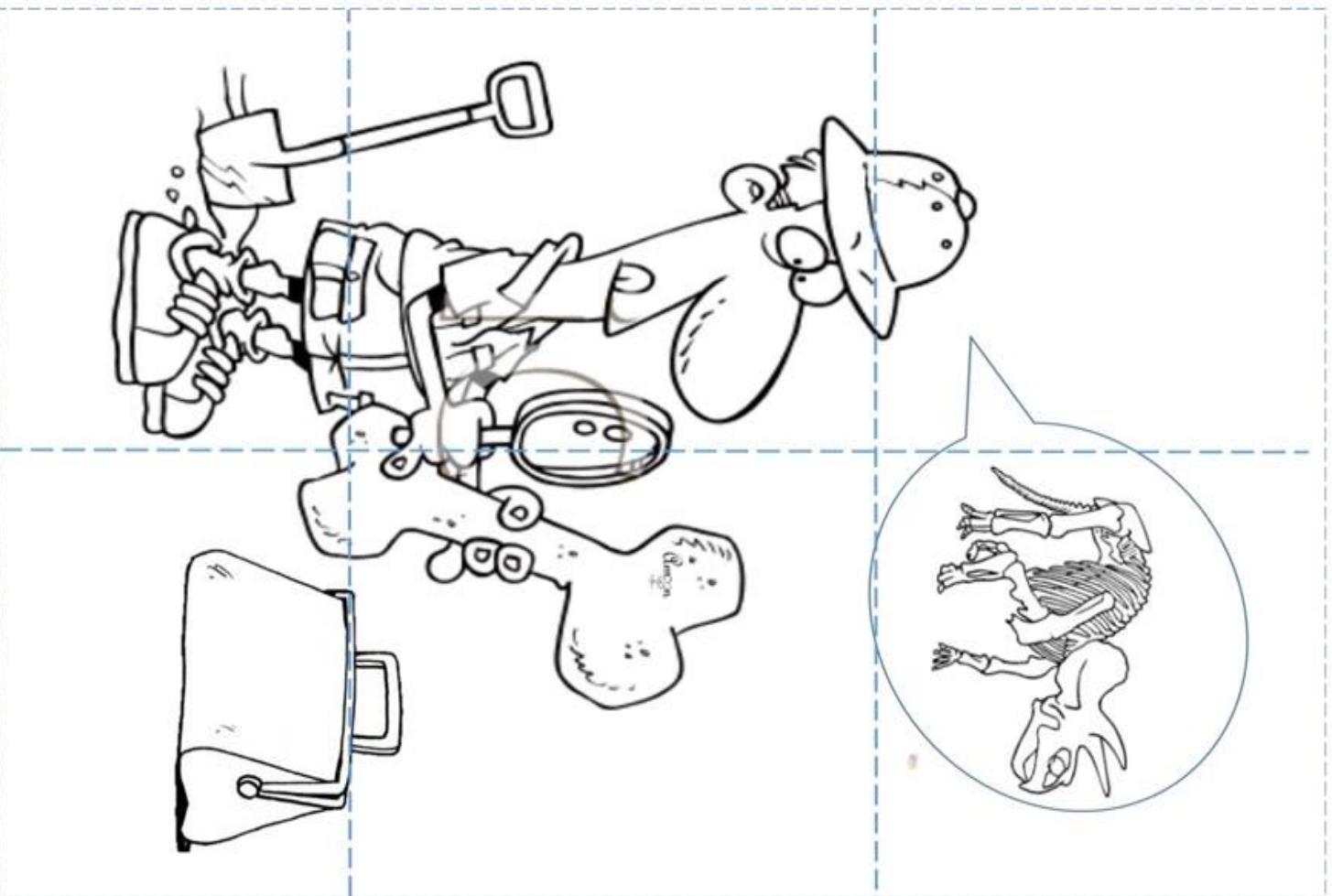

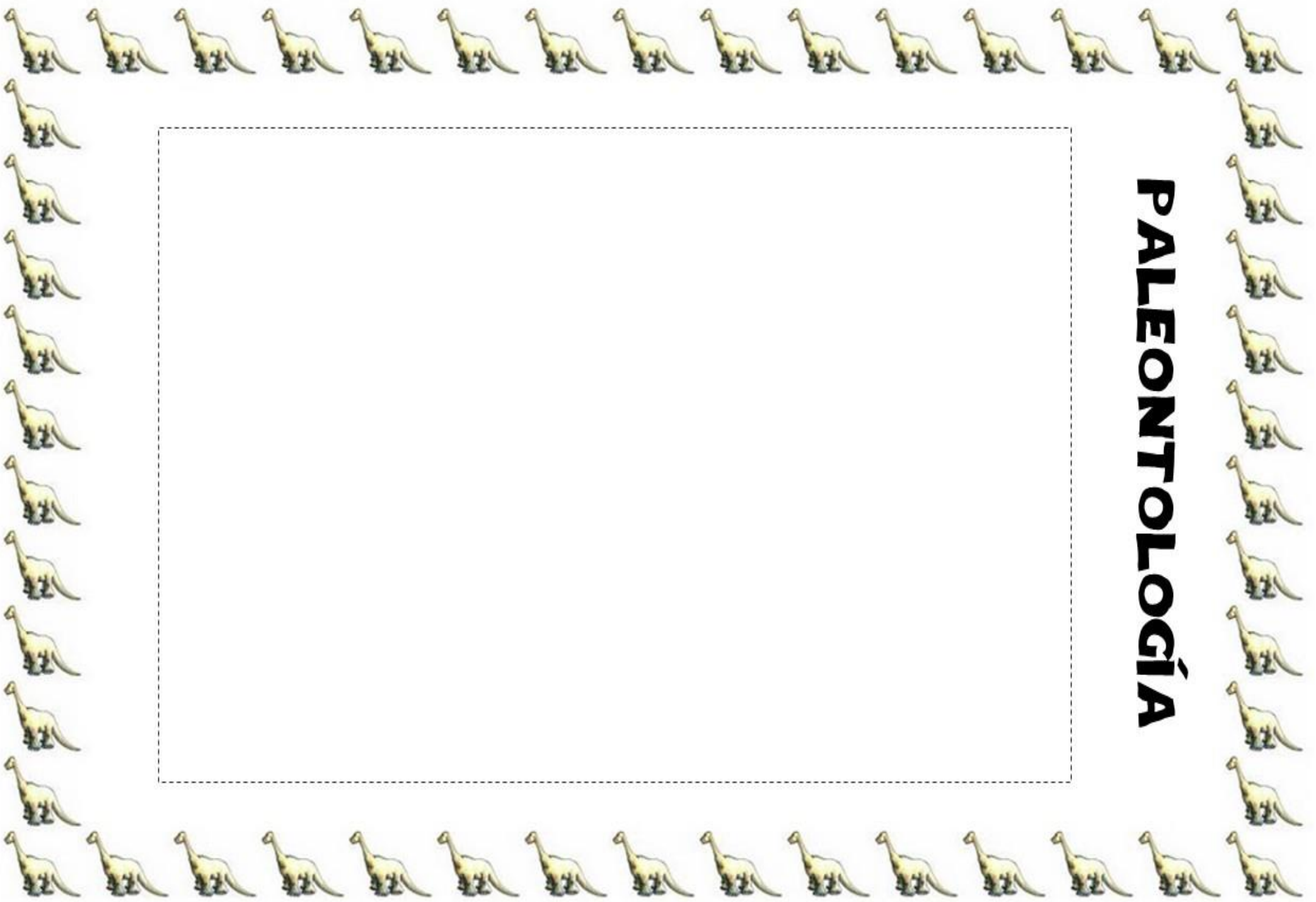

PALEONTOLOGÍA



DIBUJO FINAL

¿QUÉ HEMOS APRENDIDO DE LOS DINOSAURIOS?